



FRTW DESIGN AND CONSTRUCTION GUIDE

HOOVER
TREATED WOOD PRODUCTS, INC.



FIRE-RETARDANT-TREATED WOOD / LISTED, LABELED, & PRESSURE-IMPREGNATED

PYRO-GUARD®

EXTERIOR FIRE-X®

TABLE OF CONTENTS

INTERIOR VS EXTERIOR APPLICATIONS	2	FRTW CODE REQUIREMENTS	14
APPLICATIONS IN ACTION	3	FRTW & THE STEINER TUNNEL TEST	15
LOGISTICS	5	FIRE RESISTANCE	17
ORDERING CONSIDERATIONS.....	6	ROOFING SYSTEMS AND AHJs.....	18
INTRODUCTION TO FRTW	7	PYRO-GUARD® DESIGN VALUES.....	19
LISTED, LABELED, & PRESSURE-IMPREGNATED ...	9	EXTERIOR FIRE-X® DESIGN VALUES	20
FRTW CODE REFERENCES.....	12	REFERENCED STANDARDS	21
TYPES OF CONSTRUCTION	13	CSI FORMAT SPECIFICATION	22



In business since 1955, Hoover Treated Wood Products, Inc. (“Hoover”) manufactures a comprehensive portfolio of pressure-impregnated, kiln-dried wood products, such as lumber, plywood, glulam, and LVL products. This guide focuses exclusively on fire-retardant-treated wood (FRTW).

Hoover manufactures Pyro-Guard® and Exterior Fire-X® fire-retardant-treated wood for interior-protected and weather-exposed applications, respectively. Pyro-Guard® and Exterior Fire-X® lumber and plywood offer the economy, workability, and versatility of wood as well as the fire-safety and insurance advantages of noncombustible materials.

**WOOD THAT HAS BEEN
IMPREGNATED WITH
CHEMICALS
(PRESSURE-TREATED)**

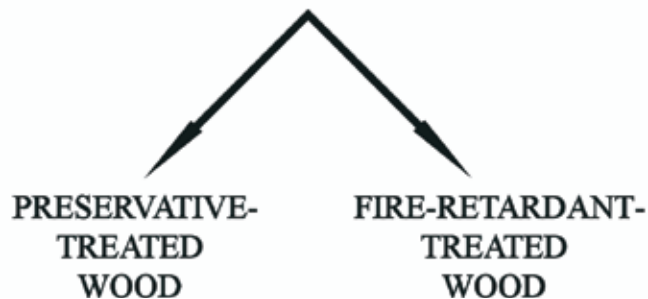

NOTE: This guide refers frequently to the International Building Code (IBC) sections that address FRTW. All code citations are colored green and are from the 2018 IBC unless indicated otherwise. *Italicized words* in the code citations are extremely important and are defined in the IBC. Words in **GREEN, BOLD, CAPITALIZED LETTERS** indicate that emphasis has been added to the code section.

DISCLAIMER OF LIABILITY FOR RELIANCE ON INFORMATION PROVIDED BY HOOVER TREATED WOOD PRODUCTS, INC.: The information contained herein is true and accurate to the best of our knowledge, but is provided without warranty or guarantee. Since the conditions of use are beyond our control, Hoover Treated Wood Products, Inc. (“Hoover”) disclaims all liability and assumes no legal responsibility for damages resulting from use of or reliance upon the information contained herein.

INTERIOR VS EXTERIOR APPLICATIONS

Pyro-Guard® and Exterior Fire-X® can be used in many applications where noncombustible materials are required by building and fire codes. Examples include: blocking, nonbearing partitions, and exterior walls; parapet alternatives and roof assemblies; exterior architectural trim and veneers; exterior-bearing walls in Type III construction; and increasingly for decks, siding, and soffits in wildfire-prone areas.

The distinction between the two products depends on weather exposure: Pyro-Guard® is used for weather-protected applications, and Exterior Fire-X® is used for weather-exposed applications. Both Pyro-Guard® and Exterior Fire-X® plywood products are produced with Exposure 1 and Exterior glue-line bond classifications.

Pyro-Guard® is used for exterior-wall assemblies. Although the FRTW is in the exterior wall, it is protected by the exterior cladding. The FRTW is inside the weather-protective envelope and is therefore not permanently exposed to the weather, making it a protected, interior application.



FIRE-RETARDANT-TREATED WOOD APPLICATION SELECTOR CHART

APPLICATION	PYRO-GUARD®	EXTERIOR FIRE-X®	APPLICATION	PYRO-GUARD®	EXTERIOR FIRE-X®
Damp Interior		🔥	Rooftop Decks		🔥
Exterior Above Ground		🔥	Scaffold Plank, Exterior		🔥
Exterior Balconies		🔥	Scaffold Plank, Interior	🔥	🔥
Exterior Decks		🔥	Soffits, Fascia		🔥
Exterior Siding		🔥	Store Fixtures	🔥	🔥
Exterior Stairways		🔥	Swimming Pool Enclosures		🔥
Fire Blocking	🔥	🔥	Trellises		🔥
Flat Roof Blocking	🔥	🔥	Trusses, Interior	🔥	🔥
Mezzanine Floors	🔥	🔥	Trusses, Weather Exposed		🔥
Picnic Tables		🔥	Underlayment/Subfloors	🔥	🔥
Plywood Roof Sheathing	🔥	🔥	Wall Sheathing	🔥	🔥
Roof Decking, Lumber	🔥	🔥	UL Design No. V314	🔥	

APPLICATIONS IN ACTION



Type I: 1.2 million SF panelized roof system used Pyro-Guard® lumber and plywood. Phoenix, AZ.



Type II: Pyro-Guard® can be used for nonbearing partitions in new/existing construction. Denver, CO.



Type II: Pyro-Guard® pitched roof system used as a nail base for 3D architectural shingles in Tulsa, OK.



Type III: UL Design No. V314 used Pyro-Guard® for the 2-hour bearing exterior walls in Draper, UT.



Pyro-Guard® roof systems can eliminate sprinklers in concealed spaces of any type of construction.



Pyro-Guard® plywood used four feet on each side of a wall to eliminate parapets. St. Petersburg, FL.



Type III with Type I podium: Pyro-Guard® used both above and below the podium. Charleston, SC.



Exterior Fire-X® is often used in weather-exposed applications like this hotel pergola in Denver, CO.



Pyro-Guard® is frequently used as blocking in the walls of Type I and II construction. Cleveland, OH.



Sprinklers may be eliminated from balconies constructed of Exterior Fire-X®. Kansas City, MO.



Pyro-Guard® lumber and plywood are used for the construction of outdoor/mall kiosks. Charlotte, NC.



Exterior Fire-X® used in the wildland-urban interface (WUI) for decking, siding, and so much more!

LOGISTICS

As the United States' leading manufacturer of FRTW, Hoover's 10 industrial wood-treating plants and a select group of licensees service a network of over 100 stocking distributors. This network of manufacturers, suppliers, and distributors ensures a global reach.

Whether by ship, rail, truck, LTL, containers, or any other mode—with Hoover's logistical help—Pyro-Guard® and Exterior Fire-X® can be transported to anywhere you need it, when you need it.



Hoover is also a multi-site SmartWood Chain of Custody company, with each of its manufacturing facilities capable of processing and shipping Forest Stewardship Council (FSC)-certified wood. FSC-certified wood has been manufactured and distributed under the Chain-of-Custody certification acceptable to the standards of the FSC.

Many local dealers maintain an inventory as well, and special orders can be direct-shipped on short notice, including FSC-certified wood. This availability is designed to meet the demands of the U.S. Green Building Council's Leadership in Energy and Environmental Design (LEED) building rating system.

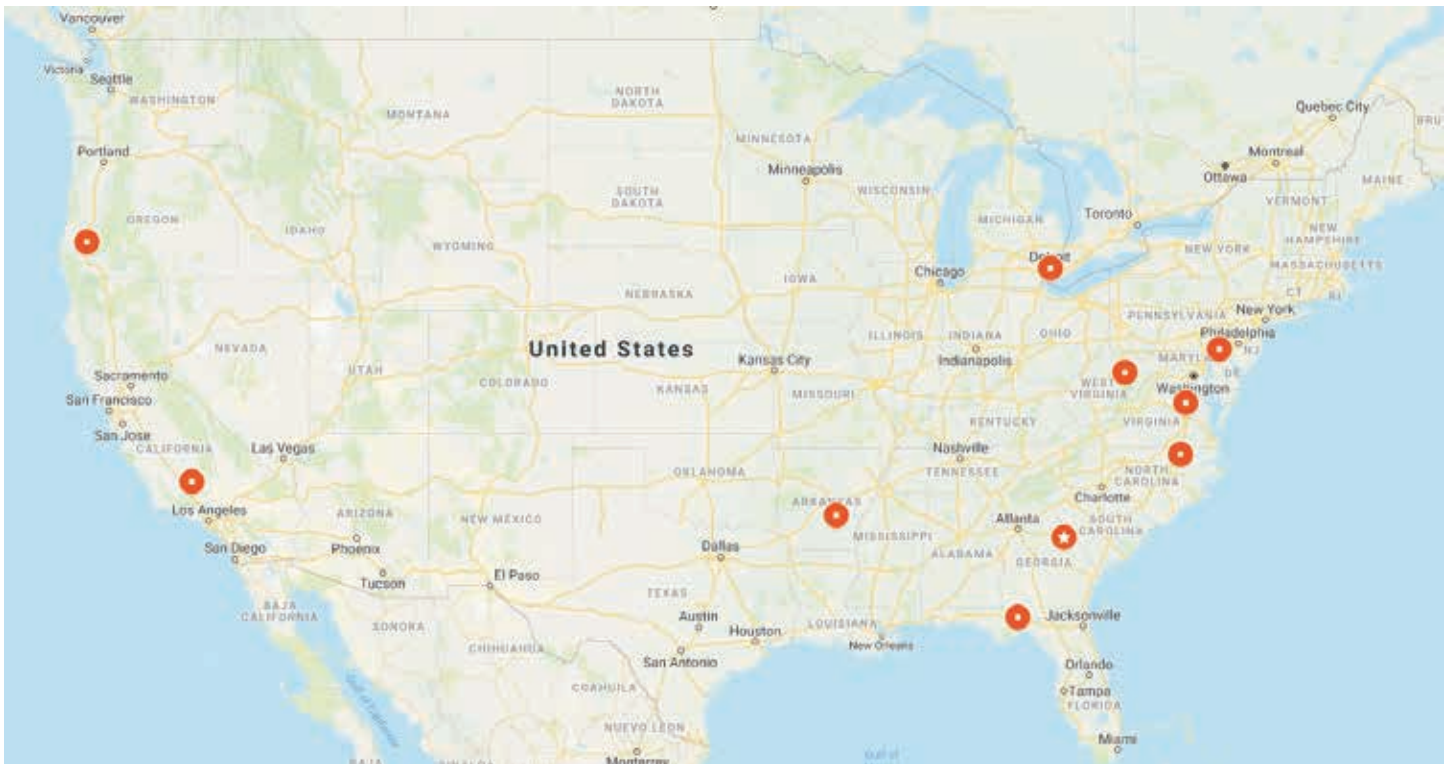

Plant Locations: Thomson, GA; Pine Bluff, AR; Milford, VA; Detroit, MI; Winston, OR; Bakersfield, CA; Belington, WV; Halifax, NC; Oxford, PA; Havana, FL

ORDERING CONSIDERATIONS

Appearance

Drying stick marks may appear on both faces of lumber and plywood. Pyro-Guard® and Exterior Fire-X® can be ordered with stick marks on one face only, which is recommended for exterior siding. Specify the mark-free side when placing the order.

Color

Exterior Fire-X Blue® is available for the nuclear power and ship-building industries. The blue color is a Department of Defense requirement. Specify “No Color” when a natural appearance is desired.

Customers will often request Pyro-Guard® to be colored as well. When specified, Hoover will produce Pyro-Guard® in red. **However, color additives are not a substitute for code-required labeling.** Hoover highly recommends that Pyro-Guard® be specified without color to avoid confusion in the marketplace.

Decay and Termite Resistance

Pyro-Guard® is not labeled as a preservative, but it does provide some protection against decay and termites in non-ground contact exposures. Pyro-Guard Plus® is available by special order for applications requiring labeled preservative efficacy.

Product Availability

Readily available, stocked Pyro-Guard® lumber will be Southern Pine, Spruce-Pine-Fir (SPF), Hem-Fir, or Douglas fir, depending on market. Stocked Pyro-Guard® plywood is Southern Pine or Douglas fir.

Pyro-Guard® is stocked in common structural and appearance grades of lumber. Pyro-Guard® plywood is widely available in sheathing grades of most thicknesses, as well as many sanded (AC, BC) and underlayment grades and thicknesses.

Exterior Fire-X® lumber and plywood are stocked in Southern Pine and Douglas fir. Exterior Fire-X® lumber is also available in Western Red Cedar and Redwood by special order. Exterior Fire-X® siding is available in APA 303 plywood siding profiles and lumber lap siding patterns in cedar, pine, and fir.

Special Ordering

In addition to products stocked through distribution, other FRTW items are available by special order. Please contact our Sales Department for more information: sales@frtw.com or 1-800-531-5558.

Storage

Pyro-Guard® and Exterior Fire-X® wood products are kiln-dried after treatment (KDAT). Kiln-drying restores stiffness and strength, increases dimensional stability, and reduces shipping weight. Keep products dry prior to installation by storing under shelter, elevating bundles from ground contact, and allowing for air circulation around the wood.

Warranty

Hoover warrants Pyro-Guard® against defects in manufacture where the product is properly installed. This warranty entitles the holder to repair or replacement of defective material, including the reasonable cost of labor and materials. **NO FINE PRINT!**

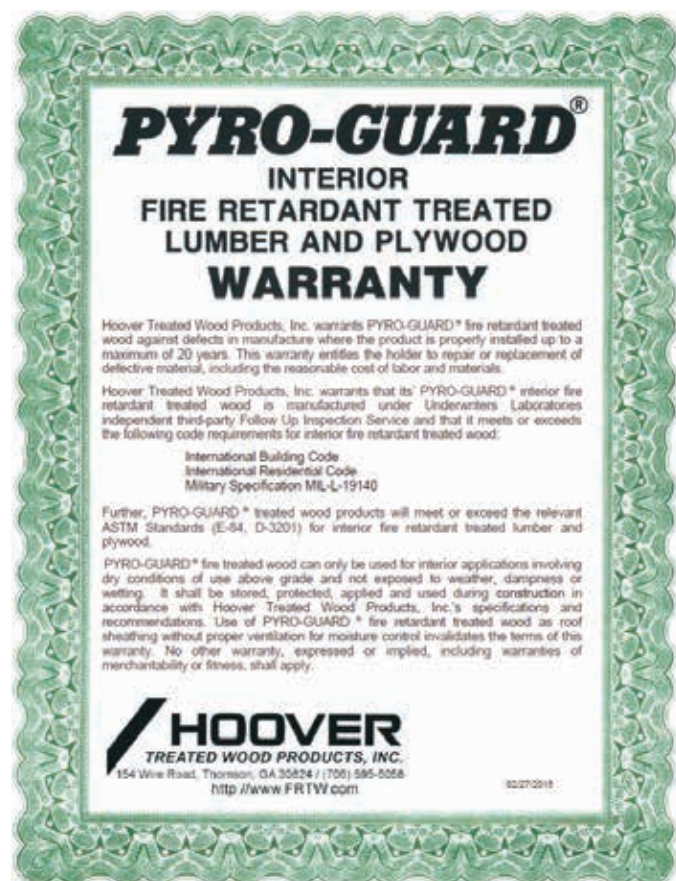

INTRODUCTION TO FRTW

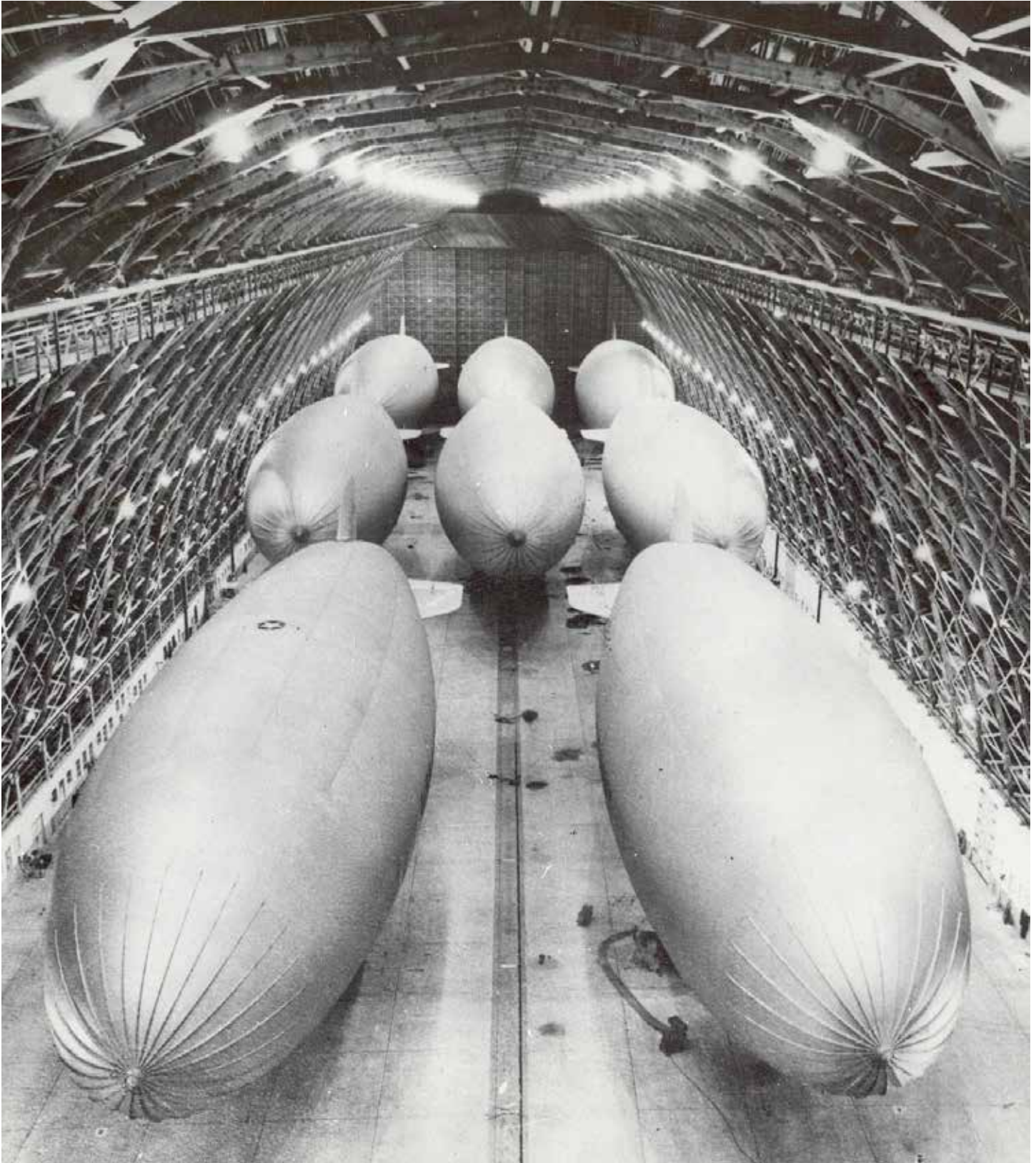

During World War II, over 55 million board feet of fire-retardant-treated lumber and plywood were used to build 17 blimp hangars, identical to this 1072-foot long, 192-foot tall, 296-foot wide hangar. Several still stand today. In 1955, a fire at one of the hangars demonstrated the effectiveness of FRTW in preventing spread of fire and was the impetus for establishing FRTW code provisions.

Fire-retardant treatment of wood by pressure impregnation was commercialized by the Electric Fire-Proofing Company in 1895. The first important demands for FRTW came from the building industry in New York City and from the U.S. Navy for use in ship construction.

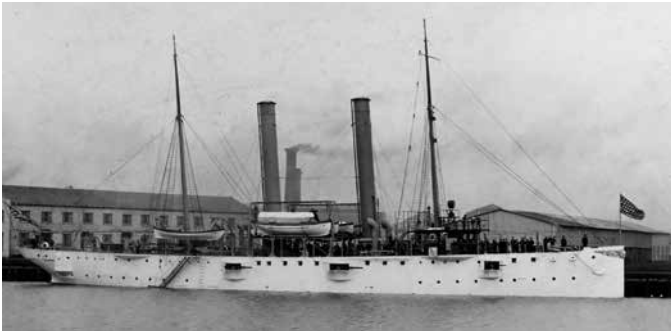

The U.S.S. Nashville was the first U.S. warship to use FRTW. Its FRTW decking provided protection from hot embers.

The tremendous military demands for FRTW in the early 1940s caused the industry to expand nationwide. Its principal uses were for the construction of blimp hangars, ship scaffolding, and other wartime structures.

In the 1960s, the model building codes published the first provisions for FRTW as a structural alternative to noncombustible materials (e.g., steel and concrete). Many FRTW applications exist in the codes today as shown on page 12.



In 1953, a fire in a casein glue factory demonstrated the superior fire-endurance of untreated wood over steel.



The identical contents within an untreated wood structure (left) and a Pyro-Guard® wood structure (right) were set on fire. After 15 minutes, the untreated structure became fuel and continued to burn. The Pyro-Guard® structure self-extinguished after the combustible contents were consumed, demonstrating FRTW doesn't add fuel to the fire and complies with EKOC 3.14.

LISTED, LABELED, & PRESSURE-IMPREGNATED

FRTW LISTINGS

All codes require FRTW to be *listed*. When a product is *listed*, it indicates that it has been tested for conformance to an applicable standard, the results are published in a maintained list, and it is subject to third-party inspection and quality assurance (QA). This verifies that the minimum level of quality required by the appropriate standard is maintained. The listing agency performing the third-party oversight must be approved by the code official. This approval requires the building official to have extraordinary trust in the *approved agency* and its abilities.

Through its Classification and Follow-Up Services program, UL verifies the material's quality and provenance of production through countercheck and on-site surveillance. **NOTE:** the UL listing for FRTW only applies to products marked "UL Classified."

FRTW LABELS

In addition to being *listed*, the FRTW is also required by the codes to be *labeled*. These permanent labels must be on each piece of FRTW and must be visible to building and fire inspectors. Labeling provides a readily available source of information that is useful for field inspection of installed products.

The code-required FRTW label (shown on page 10) establishes conformance to the standards used for determining the physical and mechanical properties of FRTW. The UL Evaluation Report (ER) in the label demonstrates conformance to code requirements. It ensures that the treatment and processes utilized for manufacturing the labeled product are the same as those used to establish the fire classification and design values referenced in the evaluation report. [UL ER7002-01](#) also provides additional information on the various UL listings and product designations for Hoover's FRTW products.

The "UL Classified" mark is the code-required *mark* of an *approved agency*, signifying conformance to applicable FRTW standards.

CODE LABELING REQUIREMENTS

Every FRTW label contains the following items per 2018 IBC §2303.2.4:

1. The identification *mark* of an *approved agency* in accordance with the model code.
2. Identification of the treating manufacturer.
3. The name of the fire-retardant treatment.
4. The species of wood treated.
5. Flame spread and smoke-developed index.
6. Method of drying after treatment.
7. Conformance with appropriate standards in accordance with the model code.
8. For *fire-retardant-treated wood* exposed to weather, damp or wet locations, include the words "No increase in the *listed* classification when subjected to the Standard Rain Test" (ASTM D2898).

PRESSURE IMPREGNATION

During the pressure impregnation process, the air in the wood cells is replaced with water solutions of fire-retardant chemicals.

In the *pressure process* (shown on page 10):

- A. Untreated wood is loaded into a cylinder.
- B. The cylinder door is sealed, and a vacuum is applied to remove air from the cylinder.
- C. The treatment is pumped into the cylinder.
- D. The pressure in the cylinder is increased, forcing the treating solution deep into the wood.
- E. The treating solution is pumped out, and a second vacuum removes any excess treatment.
- F. The treated wood is moved to a kiln to be dried using carefully controlled moisture conditions.

The codes require FRTW to be dried after treatment to moisture contents of 19% or less for lumber and 15% or less for plywood.

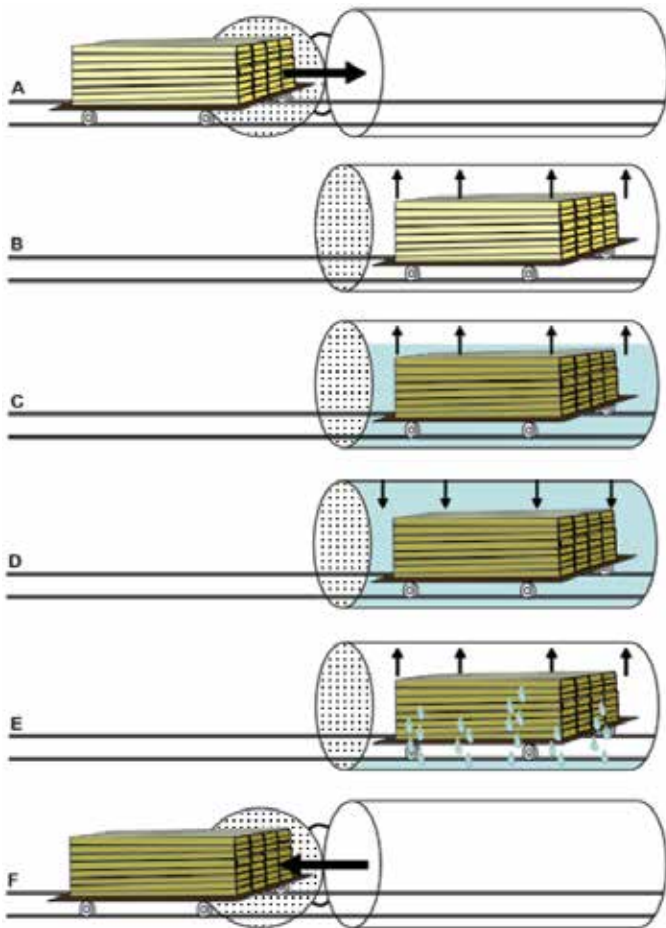
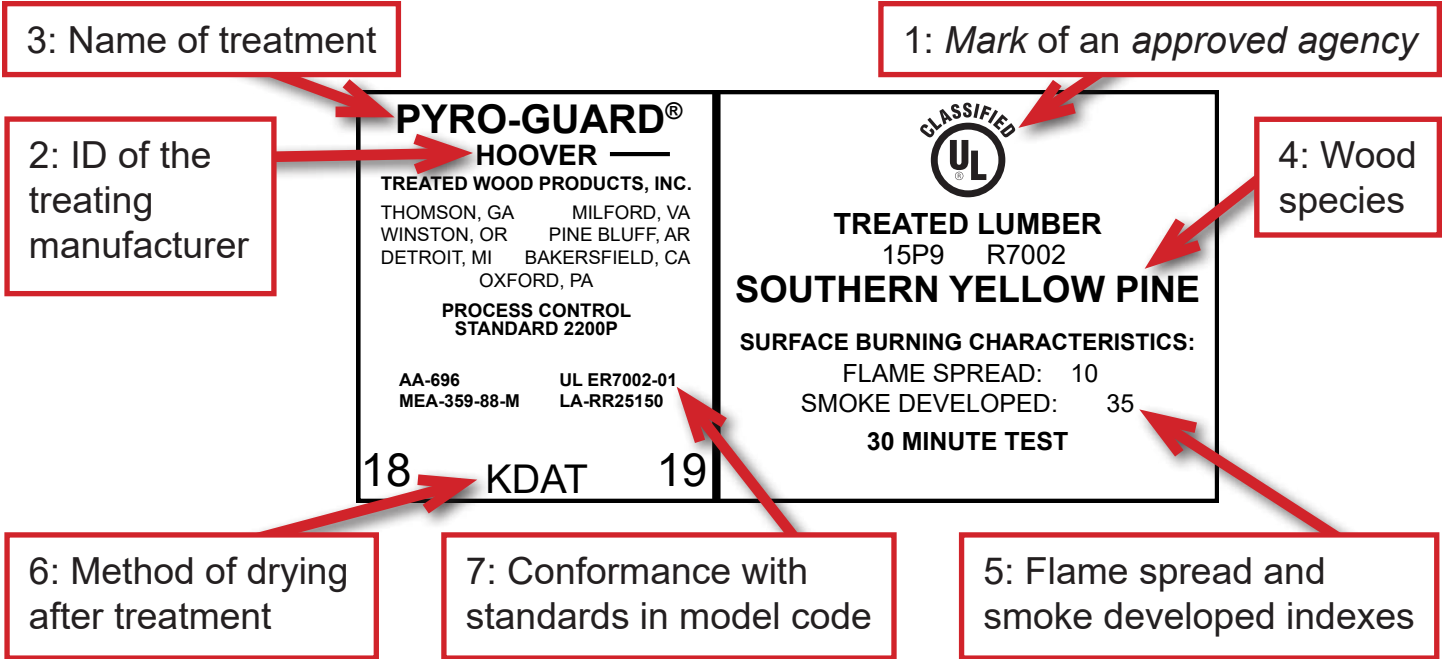

Source: Adapted from USDA Forest Service, Forest Products Laboratory (2010). *Wood Handbook: Wood as an Engineering Material*. General Technical Report, FPL-GTR-190, p. 15-19.

COATINGS ARE NOT FRTW

Paints, coatings, stains, and other surface treatments are superficial as they do not impregnate the wood and thus, as the codes state, are:

“NOT AN APPROVED METHOD OF PROTECTION AS REQUIRED.”

(See 2018 IBC §2303.2.2)



Kilns are used for drying lumber and plywood after treating. Carefully removing water from the wood results in consistent, high-quality FRTW.



Hoover, with UL Design No. V314, revolutionized wood-frame construction like this Type III, five-story, 387-unit complex on Lake Carolyn in Irving, TX. FRTW in Type III construction allows additional stories, greater heights and areas, and an overall increase in the number of units per acre compared to traditional Type V construction.

UL DESIGN NOS. V314 and NFPA 285

The V314 assembly is a two-hour, load-bearing wall assembly containing FRT lumber and plywood. It is proprietary to Hoover and requires five components:

1. 15/32" Pyro-Guard® plywood.
2. Mineral wool or fiberglass insulation.
3. Pyro-Guard® framing lumber, 2x4 or greater.
4. 5/8" Type X gypsum board.
5. 5/8" Type X gypsum board.

For the exterior, any facing (cladding) is allowed as permitted by the authority having jurisdiction.

UL V314 has been tested to the vertical and lateral flame propagation requirements of NFPA 285 and complies with 2018 IBC §1402.5.

For more information, visit ulv314.com.

For our NFPA 285 listing, see UL EWS0045.



FRTW CODE REFERENCES

FRTW APPLICATIONS	IBC 2015 Ed.	NFPA 5000 2015 Ed.	NFPA 101 2015 Ed.	IBC 2018 Ed.	NFPA 5000 2018 Ed.	NFPA 101 2018 Ed.
Architectural trim, exterior wall coverings	1406.2.1#3	37.2.1	*	1405.1.1#3	37.2.1	*
Attics: Sprinklers not required in residential occupancies		See occupancy chapters		903.3.1.2.3	See occupancy chapters	
Awnings & canopies	3105.3	32.4.2.1(3)	*	3105.2	32.4.2.1(3)	*
Balconies, porches, decks, and exterior stairways	1406.3	37.2.2.2	*	603.1#1.4	37.2.2.2	*
Bay and oriel windows	1406.4	37.2.2.1	*	705.2.4	37.2.2.1	*
Children playground structures in malls	424.2#1		*	424.2#1		
Combustible projections	705.2.3	37.2	*	705.2.3	37.2	*
Exterior bearing & nonbearing walls: Type III const.	602.3	7.2.4.2.1	4.4.2.1 ¹	602.3	7.2.4.2.1	4.4.2.1 ¹
Exterior bearing & nonbearing walls: Type IV const.	602.4.1	7.2.5.6.7	4.5.6.7 ¹	602.4.1	7.2.5.6.7(3)	4.5.6.7 ¹
Exterior nonbearing walls in Types I & II construction	603.1#1.2	7.2.3.2.12.1	4.3.2.12.1 ¹	603.1#1.2	7.2.3.2.12.1	4.3.2.12.1 ¹
Enclosed combustibile spaces in sprinklered buildings of all types of construction: Sprinklers not required	NFPA 13: 1999 ed. 8-13.1.1#9; 2002 ed. 8.14.1.2.11; 2007-2016 ed. 8.15.1.2.11; 2019: 9.2.1.12					
Fire barrier: See partitions Types I & II construction	603.1#1.1	7.2.3.2.11.2	4.3.2.11.2 ¹	603.1#1.1	7.2.3.2.11.2	4.3.2.11.2 ¹
Fuel dispensing station (marine and motor vehicle)	406.7.2	32.4.5.2	*	406.7.2	32.4.5.2	*
Grandstands: Allowable areas increased					32.7.5.2(5)	12.4.9.3.3
Grandstands: Allowable heights increased		32.7.5.4	12.4.8.3.3		32.7.5.4	12.4.9.3.6
Interior finish with flame spread index ≤ 25 (Class A)	803.1.1	10.3.2.1	10.2.3.4(1)	803.1.2	10.2.3.3(1)	10.2.3.3(1)
Kiosks in covered and open mall buildings	402.6.2	27.4.4.12.1	36.4.4.8(1)	402.6.2#1.1	27.4.4.13.1(1)	36.4.4.11(1)(a)
Liquid storage rooms (shelving, racks, and wainscotting)	415.11.5.2#3	9.3.6 ³	9.3.6 ³	415.11.5.2#3	9.3.4 ³	*
Mechanical equipment screens				1510.6.2#2		
Parapet not required: FRTW sheathing:						
Exterior walls	705.11#5.1	37.1.3.1	*	705.11#5.1	37.1.3.1(6)(b)	*
Fire and party walls in Types III, IV, and V	706.6#4.3	8.3.3.7.4.2	6.6.4.1 ²	706.6#4.3	8.3.3.7.4.2	6.6.4.2 ²
Townhouses: Exterior and common wall use within 4ft of such walls	Intl. Residential Code: R302.2.2	22.5.4	*	Intl. Residential Code: R302.2.4	22.5.4	*
Partitions (2 hr or less) in Types I & II construction	603.1#1.1	7.2.3.2.11.2	4.3.2.11.2 ¹	603.1#1.1	7.2.3.2.11.2	4.3.2.11.2 ¹
Partitions (fixed) establishing corridors in buildings with one tenant serving no more than 30 people	603.1#11	7.2.3.2.11.2	*	603.1#11	7.2.3.2.11.2	*
Pedestrian walkways	3104.3#2	7.2.3.2.9.2	*	3104.3#2		*
Platforms in Types I, II, and IV construction	410.4	7.2.3.2.7	4.3.2.7 ¹	410.3	7.2.3.2.7	4.3.2.7 ¹
Plenums in all types of construction	Intl. Mechanical Code: 602.2.1	7.2.3.2.14.2	4.3.2.15.1 ¹	Intl. Mechanical Code: 602.2.1	4.3.11.2.6(2) ⁴	
Ramps			7.2.5.4.1(3)		11.2.5.4.1(2)	7.2.5.4.1(2)
Roof construction in Types I & II construction	603.1#1.3	7.2.3.2.9.2	4.3.2.9.2 ¹	603.1#1.3	7.2.3.2.9.2	4.3.2.9.2 ¹
Roof construction in Types I, IIA, IIIA, & VA construction when ≥ 20 ft. above the floor	Table 601, Footnote b	7.2.3.2.8 (Types I & II)	4.3.2.9.1 ¹ (Types I & II)	Table 601, Footnote b	7.2.3.2.8 (Types I & II)	4.3.2.9.1 ¹ (Types I & II)
Rooftop structures (penthouses)	1510.2.5		*	1510.2.4		*
Shakes and shingles: Wood	1505.6	38.3.2	*	1505.6	38.3.2	*
Scenery and stage properties (new construction)			12.4.6.11.3			12.4.6.11.3
Scenery and stage properties (existing construction)			13.4.6.11.3			13.4.6.11.3
Wood veneer	1405.5.1		*	1404.5#1		*
Walls and ceiling furred & dropped more than 1-3/4"	803.13.2.1		*	803.15.2.1		*

*See the building code ¹NFPA 220 ²NFPA 221 ³NFPA 30 ⁴NFPA 90A

TYPES OF CONSTRUCTION

Building and fire codes recognize FRTW’s unique properties in many circumstances, permitting substitution for noncombustible materials. The table on page 12 lists the most common model code applications for FRTW alphabetically in the left-hand column. The right-hand columns provide the code or standard section.

The types of construction, I through V, referred to in the table distinguish between combustible or noncombustible construction and the degree of fire resistance of the primary structural framing material. Combustibility and fire resistance are separate determining factors in type of construction.

The principal structural elements in Types I and II construction are required to be noncombustible, with exceptions for FRTW. Types III through V are primarily wood construction: Type III is wood frame with exterior walls of noncombustible or FRTW, Type IV is heavy timber, and Type V is conventional wood frame. The “A” in the IBC types typically designates higher fire resistance compared to “B”. Some “B” construction types have no fire resistance ascribed. The NFPA classification system designates the five types of construction followed by three numbers (332, 211, etc.) indicating the hourly fire-resistance rating requirement for specific structural elements (see the table below).

Type	Designation	
	IBC	NFPA
Noncombustible	Type I (A)	Type I (332)
	Type I (B)	Type I (211)
	Type II (A)	Type II (111)
	Type II (B)	Type II (000)
Mixed noncombustible and combustible including frame and heavy timber (HT)	Type III (A)	Type III (211)
	Type III (B)	Type III (200)
	Type IV (HT)	Type IV (2HH)
Combustible – traditional wood frame	Type V (A)	Type V (111)
	Type B (B)	Type V (000)

To use FRTW in lieu of noncombustible materials, it must be impregnated with chemicals. FRTW code language is performance-based, and methods other than impregnation are not allowed, even if the fire performance criteria are met. The IBC demands that the treatment method ensures the durability and efficacy of the treated material, too, as shown below:

2018 IBC FRTW CODE REQUIREMENTS

2303.2 Fire-retardant-treated wood. *Fire-retardant-treated wood* is any wood product that, when impregnated with chemicals by a pressure process or other means during manufacture, shall have, when tested in accordance with ASTM E84 or UL 723, a *listed* flame spread index of 25 or less and show no evidence of significant progressive combustion when the test is continued for an additional 20-minute period. Additionally, the flame front shall not progress more than 10 1/2 feet (3200 mm) beyond the centerline of the burners at any time during the test.

2303.2.1 Pressure process. For wood products impregnated with chemicals by a pressure process, the process shall be performed in closed vessels under pressures not less than 50 pounds per square inch gauge (psig) (345 kPa).

2303.2.2 Other means during manufacture. For wood products impregnated with chemicals by other means during manufacture, the treatment shall be an integral part of the manufacturing process of the wood product. The treatment shall provide permanent protection to all surfaces of the wood product. **THE USE OF PAINTS, COATING, STAINS OR OTHER SURFACE TREATMENTS IS NOT AN APPROVED METHOD OF PROTECTION AS REQUIRED IN THIS SECTION.**

2303.2.3 Testing. For wood products produced by other means during manufacture, other than a pressure process, all sides of the wood product shall be tested in accordance with and produce the results required in Section 2303.2. Wood structural panels shall be permitted to test only the front and back faces.

FRTW CODE REQUIREMENTS

2303.2.4 Labeling. In addition to the labels required in Section 2303.1.1 for sawn lumber and Section 2303.1.5 for wood structural panels, each piece of fire-retardant-treated lumber and wood structural panels shall be labeled. The label shall contain the following items:

1. The identification *mark of an approved agency* in accordance with Section 1703.5.
2. Identification of the treating manufacturer.
3. The name of the fire-retardant treatment.
4. The species of wood treated.
5. Flame spread and smoke-developed index.
6. Method of drying after treatment.
7. Conformance with appropriate standards in accordance with Sections 2303.2.5 through 2303.2.8.
8. For *fire-retardant-treated wood* exposed to weather, damp or wet locations, include the words “No increase in the *listed* classification when subjected to the Standard Rain Test” (ASTM D2898).

2303.2.5 Strength adjustments. Design values for untreated lumber and wood structural panels, as specified in Section 2303.1, shall be adjusted for *fire-retardant-treated wood*. Adjustments to design values shall be based on an *approved* method of investigation that takes into consideration the effects of the anticipated temperature and humidity to which the *fire-retardant-treated wood* will be subjected, the type of treatment and redrying procedures.

2303.2.5.1 Wood structural panels. The effect of treatment and the method of redrying after treatment, and exposure to high temperatures and high humidities on the flexure properties of fire-retardant-treated softwood plywood shall be determined in accordance with ASTM D5516. The test data developed by ASTM D5516 shall be used to develop adjustment factors, maximum loads and spans, or both, for untreated plywood design values in accordance with ASTM D6305. Each manufacturer shall publish the allowable maximum loads and spans for service as floor and roof sheathing for its treatment.

2303.2.5.2 Lumber. For each species of wood that is treated, the effects of the treatment, the method of redrying after treatment and exposure to high temperatures and high humidities on the allowable design properties of fire-retardant-treated lumber shall be determined in accordance with ASTM D5664. The test data developed by ASTM D5664 shall be used to develop modification factors for use at or near room temperature and at elevated temperatures and humidity in accordance with ASTM D6841. Each manufacturer shall publish the modification factors for service at temperatures of not less than 80°F (27°C) and for roof framing. The roof framing modification factors shall take into consideration the climatological location.

2303.2.6 Exposure to weather, damp or wet locations. Where *fire-retardant-treated wood* is exposed to weather, or damp or wet locations, it shall be identified as “Exterior” to indicate there is no increase in the *listed* flame-spread index as defined in Section 2303.2 when subjected to ASTM D2898.

2303.2.7 Interior applications. Interior *fire-retardant-treated wood* shall have moisture content of not over 28 percent when tested in accordance with ASTM D3201 procedures at 92-percent relative humidity. Interior *fire-retardant-treated wood* shall be tested in accordance with Section 2303.2.5.1 or 2303.2.5.2. Interior *fire-retardant-treated wood* designated as Type A shall be tested in accordance with the provisions of this section.

2303.2.8 Moisture content. *Fire-retardant-treated wood* shall be dried to a moisture content of 19 percent or less for lumber and 15 percent or less for wood structural panels before use. For wood kiln-dried after treatment (KDAT), the kiln temperatures shall not exceed those used in kiln drying the lumber and plywood submitted for the tests described in Section 2303.2.5.1 for plywood and 2303.2.5.2 for lumber.

2303.9 Type I and II construction applications. See Section 603.1 for limitations on the use of *fire-retardant-treated wood* in buildings of Type I or II construction.

FRTW & THE STEINER TUNNEL TEST

UL has been testing and providing third-party oversight for FRTW since 1935, when the first listing (R2282) for “fireproofed” red oak flooring was promulgated. The basis for this listing included the development of a tunnel furnace. In his thesis, Albert Steiner (1936) describes the tunnel he developed and its use for investigating the effectiveness of fireproofed red oak flooring. Standardized today as UL 723, “Test for Surface Burning Characteristics of Building Materials,” the Steiner Tunnel’s primary use has been for determining the flame spread and smoke developed indices of building materials.

The test consists of a 25-foot-long rectangular tunnel with two gas burners at one end that direct a 4 1/2-foot flame under controlled conditions of draft and temperature onto the surface of a 24-foot-long by 20-inch-wide specimen. Flame spreads along the surface of the material as the test progresses. The distance of flame travel and rate at which the flame front advances during a 10-minute exposure determine the calculated flame spread index (FSI). To provide standard conditions for each test, the tunnel is calibrated to an index of 0 for 1/4-inch cement board and 100 for untreated red oak flooring.

Keep in mind that UL 723 is conducted for 10 minutes. UL realized that this 10-minute period only demonstrated delayed ignition and gave little indication of noncombustibility. At the request of the National Board of Fire Underwriters (American Insurance Association), UL wrote a performance standard

for pressure-impregnated FRTW, which requires the test period to be extended an additional 20 minutes to a total of 30 minutes. According to UL, “[t]he data developed during the first 10 min. of the test is used to determine the flame spread, fuel contributed and smoke developed of the Fire-Hazard Classification. During the remaining 20 min., the test samples are observed to determine that the flame spread does not exceed the equivalent of 25 (5 ft. beyond the standard igniting flame) and that there is no evidence of significant progressive combustion” (Malcomson & Bono, 1967, 25).

Over the years, changes to the standard affected the calculation procedures used to determine FSI values from raw data. In order to allow listed FRTW from newer tests to remain consistent with earlier tests, an additional code criterion, as reported by NFPA (1985), was added to the codes to address what was already required by the UL listings. This additional code criterion requires that “the flame front does not progress more than 10 1/2 feet beyond the center line of the burner at any time during the test” (NFPA 1985, 27).

LITERATURE CITED

- Malcomson, R.W. & Bono, J.A. (1967, September). Underwriters’ Laboratories, Inc. Issues new labels for FRTW. *Wood Preserving News*, 24-27.
- National Fire Protection Association (NFPA). (1985). Report of Committee on Building Construction. Available online: <https://www.nfpa.org/Assets/files/AboutTheCodes/703/TCRA-1985-204M-205M-T-220-703-105M.pdf>.
- Steiner, A.J. (1936). Investigation of effectiveness of fireproofed red oak and maple lumber. MS Thesis, Armour Institute of Technology, Chicago, IL.



FINDING HOOVER'S UL LISTINGS

Hoover maintains UL product listings for Pyro-Guard® and Exterior Fire-X®:

Hoover's lumber, including glulam, is listed as [BPVV.R7002](#), and plywood, including laminated veneer lumber (LVL), is listed as [BUGV.R7003](#).

UL listings may refer to "FR-S." This UL proprietary term identifies products that have both a flame spread index and a smoke developed index of 25 or less when evaluated to UL 723 for 30 minutes. The flame fronts for these products also did not exceed 10 1/2 feet beyond the centerline of the burners at any time and showed no evidence of significant progressive combustion.

The codes require FRTW to be "impregnated with chemicals, by a pressure process or other means during manufacture." Impregnation refers to a technique for treating absorbent materials with chemicals. Impregnating wood materials with fire-retardants changes the chemical, physical, and mechanical properties of the wood, resulting in a complex new material. This new material, FRTW, is as different from untreated wood as pig iron is from structural steel.

Impregnation of wood with fire-retardant chemicals reduces the combustible properties of wood by greatly reducing the amount of volatiles released during the initial stages of combustion. The surface manifests only a slight glow, and that portion directly exposed to flame checks and chars. The yield of char is increased by slow dehydration of the wood substances and is reduced to a clinker-like charred condition, not to ordinary ash. In addition to decreasing the rate of flame spread, FRTW is self-extinguishing and ignition resistant, resulting in no flaming, glowing, or smoldering combustion after the primary source of external fuel is exhausted. In other words, in order for FRTW to burn, it must be exposed to a persistently applied, external fuel source, without which FRTW cannot ignite and sustain combustion.

Impregnation by **pressure process** is used for solid wood products, such as lumber and plywood. "**Other means during manufacture**" addresses the treatment of certain wood-fiber-based products, such as acoustical tile, and fiberboard roofing insulation and wall sheathing. In this method, chemicals are added to the wet pulp stage of the manufacturing process, resulting in an even distribution of the chemicals throughout the entire mass of the finished product.

Methods of applying fire-retardants to the surface of the wood, such as by painting and coating, do not provide the intimate mixing of chemicals and wood necessary for changing the base material's properties. Therefore, the IBC does not recognize painted or coated wood products as FRTW.

Some government organizations have their own requirements for testing the combustible properties of FRTW. One example is the 1968 New York City Building Code, which is used today for modifying buildings constructed prior to 2008. This code requires that a crib test (ASTM E160) or a fire tube test (ASTM E69) also be conducted. These tests for combustible properties of treated wood were first promulgated in the 1898 and 1938 NYC Building Codes, respectively. Another example is MIL-L-19140E, promulgated by the Department of Defense. It also requires the use of ASTM E69.

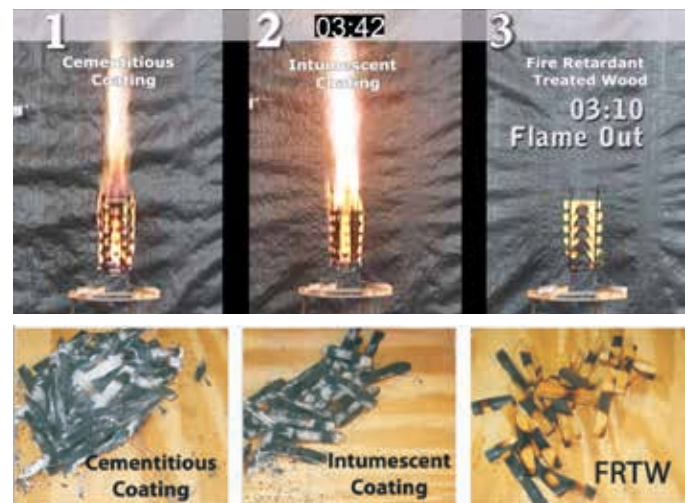

As the ASTM E160 test demonstrates, FRTW self-extinguishes when the burner is removed at 3 minutes. Coated wood does not self-extinguish and continues to burn until it is completely reduced to nothing but ash and coating residue.

FIRE RESISTANCE

Fire Resistance

Fire ratings in hours are assigned to wall, floor, and roof deck assemblies, following testing in accordance with UL 263/ASTM E119. FRTW has a surface burning classification and, by itself, does not have a resistance rating in hours any greater than untreated wood. References, such as the Underwriters Laboratories “Fire Resistance Directory,” specifically point out that FRTW may be substituted for untreated wood ([see UL Guide Information BXUY](#)). FRTW can therefore be used as a component in such assemblies in types of construction where the code does not permit the use of untreated wood.

Descriptions of fire resistant rated wall assemblies incorporating structural lumber are listed in IBC Table 721.1(2) and in several publications referenced by the IBC including:

- Fire Resistance Directory, published by Underwriters Laboratories;
- GA600-Fire Resistance Design Manual, published by the Gypsum Association.

As way of example, the GA600 contains a one hour wall or partition assembly (WP 3605) that has wood studs covered by 5/8 Type X gypsum board with specified nailing and positioning of the panels. This assembly could be used for interior, nonbearing partitions, requiring a one-hour rating in a noncombustible structure if the studs were FRTW. In a similar manner, by substituting FRTW for untreated wood, other one and two hour wall and ceiling assemblies can be used in noncombustible type buildings. For prescriptive wall assemblies utilizing FRTW, see IBC Table 721.1(2) Item Numbers 14-1.4, 14-1.6, and 15-1.6.

The IBC permits asymmetric testing for fire resistance rating (testing from the inside only) where the distance to the property line is at least 5 feet.

If sprinklering is not used for heights and areas increases, it is permitted to reduce fire resistive requirements by one hour for all construction elements except exterior walls.

Typical Type III Wall Details

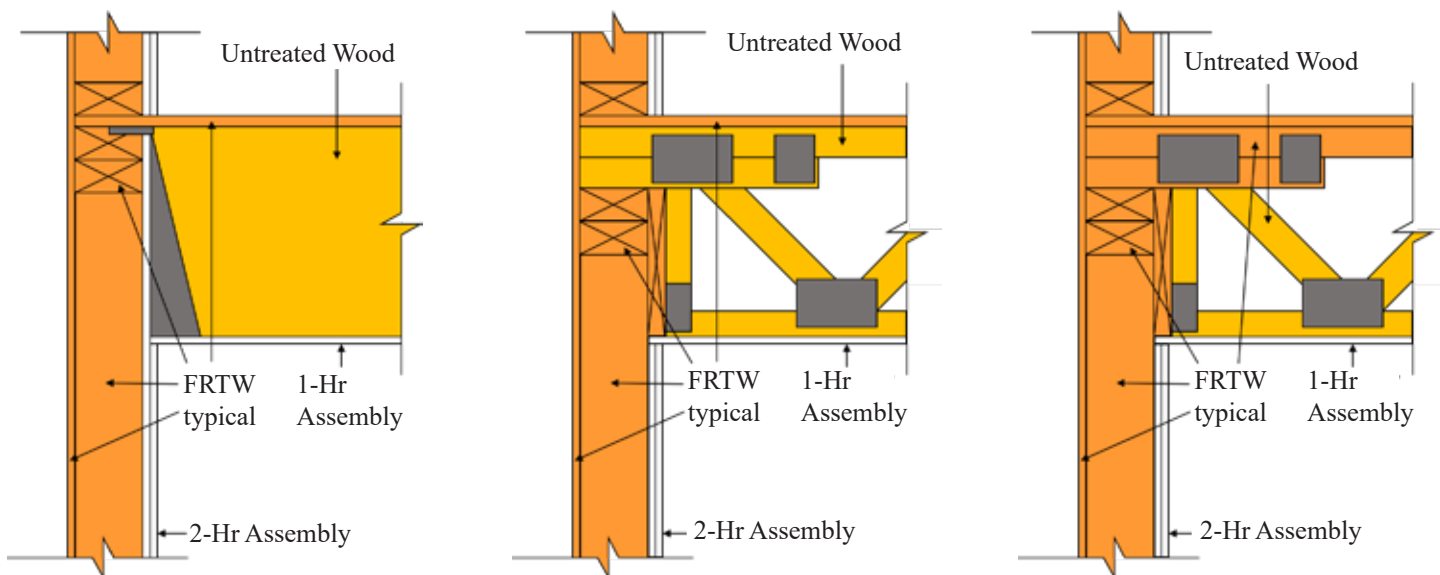

As shown above, there are many possible ways for detailing code-compliant wall systems utilizing UL Design No. V314 in Type III construction. Section 602.3 of the 2018 IBC was clarified to show that FRTW plywood sheathing complying with Section 2303.2 is allowed in the exterior bearing walls of Type III construction.

ROOFING SYSTEMS AND AHJs

ROOFING SYSTEMS

UL Classified Pyro-Guard® is certified for fire and wind uplift by UL for use with any UL Classified fully adhered EPDM, PVC, TPO, or self-adhered bitumen cap sheet roof system.

Advantages:

1. Outstanding system wind uplift rating
2. Meets UL Class C roof deck panel requirements
3. Lighter than other comparable Class C products
4. Easily cut with standard saws
5. During cutting, releases no:
 - fiberglass,
 - airborne glass fibers, or
 - crystalline silica

Compliance:

1. UL Classified for fire per UL790
(see [TGFU.R7003](#))
2. UL Listed for wind uplift per UL1897
(see [TGIK.R7003](#))

Product Data:

15/32" Pyro-Guard® plywood

- Size: 4.0' x 8.0'
- Weight: 51 lb nominal
- Wind Uplift Listing: 280 psf

23/32" Pyro-Guard® plywood

- Size: 4.0' x 8.0'
- Weight: 77 lb nominal
- Wind Uplift Listing: 270 psf

The certification for uplift resistance, expressed in lbs per sq ft (psf), is derived from tests conducted in accordance with UL 1897. This test method subjects a 10 ft by 10 ft sample to various short-term (one-minute increments) static air pressures to index performance under uplift loads imposed on a roofing system's securement to a specified roof deck.

For uplift resistance of Pyro-Guard® plywood roof deck constructions that also includes attachment to supports and is UL 1256 "Fire Classified," see [Roof Deck Construction NM501A](#).

AUTHORITIES HAVING JURISDICTION

NFPA documents use the phrase "authority having jurisdiction" (AHJ) in a broad manner, since jurisdictions and approval agencies vary as do their responsibilities. The AHJ may be federal, state, local, or a regional department or individual, such as a fire or building official; labor or health department; or others having statutory authority. For insurance purposes, an insurance inspection department, rating bureau, or other insurance company representative may be the AHJ. Often, roofing consultants, property owners, or their designated agent assumes the role of the AHJ; at government installations, the commanding officer or departmental official may be the AHJ.

As an AHJ, the Insurance Services Office (ISO) gives buildings constructed with FRTW the same fire insurance ratings as noncombustible buildings.

FRTW IN THE WILDLAND-URBAN INTERFACE (WUI)

[Executive Order 13728](#) empowers all federal agencies (AHJs) to apply the wildfire-resistant design provisions outlined in the most current edition of the International Wildland-Urban Interface Code (IWUIC) or an equivalent nationally recognized code.

To learn more about FRTW construction in the WUI, see the Colorado State Forest Service's [FireWise Construction Guide](#).

AHJs LISTINGS OF HOOVER'S PRODUCTS

- CA State Fire Marshal [BMLs](#):
 - Pyro-Guard®
 - [Lumber \(2520-1701:0103\)](#)
 - [Plywood \(2580-1701:0102\)](#)
 - Exterior Fire-X®
 - [Lumber \(2520-1701:0100\)](#)
 - [Plywood \(2580-1701:0101\)](#)
- Department of Defense QPL: See Page 21.
- Los Angeles: [LARR 25150](#)
- New York City: [MEA 357-88-M](#)

PYRO-GUARD® DESIGN VALUES

The codes require the development of strength-adjustment factors. Chemicals, treating procedures, and redrying conditions are evaluated to determine their impact on base-strength properties of untreated wood. ASTM D6305 and D6841 use test data developed in accordance with ASTM D5516 and D5664 to calculate the effects of fire-retardant treatment on use of plywood and lumber, respectively, in normal and elevated temperature exposures.

The procedures employ an elevated temperature intended to produce strength losses in a short period

of time. Although the exposure is much more severe than that which normally occurs in a roof system, the chemical reactions that occur in the laboratory test are considered to replicate those occurring over long periods of time in the field.

Treatment adjustment factors developed through these procedures are applicable to roof slopes of 3 in 12 or steeper, to roofs designed with vent areas and vent locations conforming to building code requirements, and to designs in which the bottom side of the roof sheathing is exposed to ventilation air.

Maximum Loads & Spans for Pyro-Guard® Treated Plywood¹

Plywood Thickness (Inches)	Untreated Roof / Subfloor Span (Rating)	Pyro-Guard®				Pyro-Guard® Subfloor Span (Inches)
		Roof Sheathing Span (Inches)	Maximum Live Load (psf)			
			Climate Zone			
			1A	1B	2	
15/32, 1/2	32/16	24	19	30	43	16
19/32, 5/8	40/20	24	42	64	87	20
		32	20	32	45	20
23/32, 3/4	48/24	32	34	51	71	24
		48	10	18	27	24
7/8	--	48	12	20	30	--
1-1/8	--	48	21	33	47	48

¹ See Table 2 footnotes in [UL ER7002-01](#) for complete details; [UL ER7002-01](#) can be found at [frtw.com](#).

Adjustments to Design Values for Pyro-Guard® Treated Lumber²

Property	Service Temperature to 100°F/38°C			Pyro-Guard® Roof Framing, Climate Zone					
				1A		1B		2	
	SP	DF	Other	SP	DF	SP	DF	SP	DF
Extreme fiber in bending	.91	.97	.88	.80	.90	.85	.93	.89	.96
Tension parallel to grain	.88	.95	.83	.80	.80	.84	.87	.88	.93
Compression parallel to grain	.94	1.00	.94	.94	.94	.94	.98	.94	1.00
Horizontal shear	.95	.96	.93	.92	.95	.93	.95	.94	.96
Modulus of elasticity	.95	.96	.94	.95	.96	.95	.96	.95	.96
Compression perp. to grain	.95	.95	.95	.95	.95	.95	.95	.95	.95
Fasteners/connectors	.90	.90	.90	.90	.90	.90	.90	.90	.90

² See Table 3 footnotes in [UL ER7002-01](#) for complete details; [UL ER7002-01](#) can be found at [frtw.com](#).

EXTERIOR FIRE-X® DESIGN VALUES



Adjustments to Design Values for Exterior Fire-X® Treated Lumber³

Property	Adjustment Factors
Extreme fiber in bending	0.85
Tension	0.80
Horizontal shear	0.90
Compression perp. to grain	0.90
Compression parallel to grain	0.90
Modulus of elasticity	0.90
Fastener/connector design loads	0.90



³ See [Engineering Data/Design Adjustments](http://www.frtw.com/Engineering-Data/Design-Adjustments) at [frtw.com](http://www.frtw.com) for complete details.

Maximum Spans for Exterior Fire-X® Treated Plywood⁴

Panel Thickness Category	Untreated Span Index	Exterior Fire-X® Maximum Span (Inches)	
		Roof Sheathing	Wall & Subfloor
15/32, 1/2	32/16	24	16
19/32, 5/8	40/20	32	20
23/32, 3/4	48/24	40	24
7/8	--	48	24

⁴ See [Engineering Data/Design Adjustments](http://www.frtw.com/Engineering-Data/Design-Adjustments) at [frtw.com](http://www.frtw.com) for complete details.

REFERENCED STANDARDS

STANDARDS

ASTM Standards

D2898	Standard Practice for Accelerated Weathering of Fire-Retardant-Treated Wood for Fire Testing
D3201	Standard Test Method for Hygroscopic Properties of Fire-Retardant Wood and Wood-Based Products
D5516	Standard Test Method for Evaluating the Flexural Properties of Fire-Retardant Treated Softwood Plywood Exposed to Elevated Temperatures
D5664	Standard Test Method for Evaluating the Effects of Fire-Retardant Treatments and Elevated Temperatures on Strength Properties of Fire-Retardant Treated Lumber
D6305	Standard Practice for Calculating Bending Strength Design Adjustment Factors for Fire-Retardant-Treated Plywood Roof Sheathing
D6841	Standard Practice for Calculating Design Value Treatment Adjustment Factors for Fire-Retardant-Treated Lumber
E69	Standard Test Method for Combustible Properties of Treated Wood by the Fire-Tube Apparatus
E84	Standard Test Method for Surface Burning Characteristics of Building Materials
E108	Standard Test Methods for Fire Tests of Roof Coverings
E119	Standard Test Methods for Fire Tests of Building Construction and Materials
E136	Standard Test Methods of Behavior of Materials in a Vertical Tube Furnace at 750°C
E160	Test Method for Combustible Properties of Treated Wood by the Crib Test
E2579	Standard Practice for Specimen Preparation and Mounting of Wood Products to Assess Surface Burning Characteristics
E2768	Standard Test Method for Extended Duration Surface Burning Characteristics of Building Materials (30 min Tunnel Test)

Military Standards

MIL-L-19140E	Military Specification: Lumber and Plywood, Fire-Retardant-Treated
--------------	--

U.S. QUALIFIED PRODUCTS LIST

U.S. Qualified Products List: Hoover's Pyro-Guard® and Exterior Fire-X® products are on this list and are extensively used for Department of Defense and Department of Energy projects. See: <http://qpldocs.dla.mil/search/parts.aspx?qpl=1683>.

NFPA Standards

13	Standard for the Installation for Sprinkler Systems
90A	Standard for the Installation of Air-Conditioning and Ventilating Systems
220	Standard on Types of Building Construction
221	Standard for High Challenge Fire Walls, Fire Walls, and Fire Barrier Walls
285	Standard Fire Test Method for Evaluation of Fire Propagation Characteristics of Exterior Non-Load-Bearing Wall Assemblies Containing Combustible Components
703	Standard for Fire Retardant Treated-Wood and Fire-Retardant Coatings for Building Materials
1144	Standard for Reducing Structure Ignition Hazards from Wildland Fire

UL Standards

263	Standard for Fire Tests of Building Construction and Materials
723	Test for Surface Burning Characteristics of Building Materials
790	Standard Test Methods for Fire Tests of Roof Coverings
1256	Standard for Fire Test of Roof Deck Constructions
1897	Standard for Uplift Tests for Roof Covering Systems

CODES

ICC Codes

IBC	International Building Code
IMC	International Mechanical Code
IRC	International Residential Code
IWUIC	International Wildland-Urban Interface Code

NFPA Codes

30	Flammable and Combustible Liquids Code
101	Life Safety Code
5000	Building Construction and Safety Code

HANDLING AND USE

Finishing

Pyro-Guard® and Exterior Fire-X® wood products can be painted and stained with good results. They must be dry and clean before being finished. Finishing systems should be tested on sample materials to determine if the desired effect can be obtained.

For painting or staining of FRTW, a light sanding or brushing is all that is necessary to ensure proper coating adhesion. Complete application recommendations are available from the manufacturer.

Pyro-Guard® and Exterior Fire-X® occasionally have raised grain, especially on sanded grades of plywood. This is easily removed by sanding.

Jobsite Protection

Roof and wall sheathing should be covered with a weather resistive barrier as soon as practical after installation. If wetted during construction, allow FRTW to dry before enclosing.

Personal Protection

Avoid frequent or prolonged inhalation of sawdust from any wood, including treated wood. When sawing and machining treated wood, wear suitable respiratory and eye protection.

NOTES TO SPECIFIERS

The model specification on page 22 covers the treatment, handling, and fabrication of FRTW. Lumber and plywood grades must be specified separately from treatment.

Specify only those species of lumber and plywood eligible for UL listing in the UL Building Materials Directory.

Interior FRTW can be used in a variety of interior applications where the humidity is not expected to exceed 95 percent for prolonged periods and where the FRTW is not exposed directly to weather.

When using FRTW in roof applications, local building code ventilation requirements need to be verified and addressed.

Fire-retardant treatment requirements should be expressed in the various sections where the wood itself is specified.

CSI FORMAT SPECIFICATION

SECTION 06 05 73.13 FIRE-RETARDANT WOOD TREATMENT (FIRE-RETARDANT-TREATED WOOD)

PART 1 GENERAL

1.01 SUMMARY

- A. Section includes: Fire-retardant-treated wood products specified in other Division 6 Sections, including:
 - 1. Interior fire-retardant-treated wood.
 - 2. Exterior fire-retardant-treated wood.
- B. Related Sections:
 - 1. Section 06 10 00 Rough Carpentry
 - 2. Section 06 20 00 Finish Carpentry
 - 3. Section 06 40 00 Architectural Woodwork

1.02 REFERENCES

- A. ASTM International (ASTM):
 - 1. ASTM D2898 Standard Practice for Accelerated Weathering of Fire-Retardant-Treated Wood for Fire Testing.
 - 2. ASTM D3201 Standard Test Method for Hygroscopic Properties of Fire-Retardant Wood and Wood-Based Products.
- B. Military Specification:
 - 1. MIL-L-19140E Lumber and Plywood, Fire-Retardant Treated.
- C. Underwriters Laboratories, Inc. (UL):
 - 1. UL 723 Standard for Test for Surface Burning Characteristics of Building Materials.

1.03 PERFORMANCE REQUIREMENTS:

- A. Provide fire-retardant-treated wood that complies with the following when tested in accordance with UL 723:
 - 1. A listed flame spread index of 25 or less.
 - 2. No evidence of significant progressive combustion when the test is continued for an additional 20-minute period.
 - 3. A flame front that does not progress more than 10½ feet beyond the centerline of the burners at any time during the 30-minute test period.
- B. Provide fire-retardant-treated wood that is kiln dried after treatment (KDAT) to maximum moisture content of 19% for lumber and 15% for plywood.
- C. Provide interior fire-retardant-treated wood that has a moisture content less than 28% when tested in accordance with ASTM D3201 at 92% relative humidity.
- D. Provide exterior fire-retardant-treated wood that has no increase in the listed classification when subjected to the Standard Rain Test, ASTM D2898.

1.04 SUBMITTALS

- A. General: Submit listed submittals in accordance with Conditions of the Contract and Section 01 33 00 - Submittal Procedures.
- B. Product Data: Submit the following for specified products.
 - 1. Manufacturer's storage, handling and installation recommendations.
 - 2. Manufacturer's finishing recommendations.
 - 3. Safety Data Sheets (SDS).
- C. Quality Assurance Submittals: Submit the following:
 - 1. DoD Qualified Product List (QPL) with Preamble.
 - 2. UL Classifications with Guide.
- D. Closeout Submittals:
 - 1. Warranty: Submit warranty documents specified.

1.05 QUALITY ASSURANCE

- A. Qualifications:
 - 1. Wood treatment qualified under MIL-L-19140E and listed on the Qualified Product List (QPL).
 - 2. Wood treatment plant with ongoing UL Classification and Follow-Up Service for fire-retardant-treated wood.

1.06 WARRANTY

- A. Refer to Conditions of the Contract and Section 01 78 36 for project warranty provisions.
- B. Manufacturer's Warranty: Submit, for Owner's acceptance, manufacturer's standard warranty document executed by authorized company official. Manufacturer's warranty is in addition to, and not a limitation of, other rights Owner may have under the Contract Documents.

PART 2 PRODUCTS

2.01 FIRE-RETARDANT-TREATED WOOD

- A. Manufacturer: Any manufacturer listed in the UL Online Certifications Directory for Treated Lumber (BPVV) and Treated Plywood (BUGV) at the time set for opening of bids.
- B. Fire-Retardant Treatment: Any treatment listed in the Department of Defense (DoD) Qualified Product List (QPL) for MIL-L-19140E at the time set for opening of bids.
- C. Labeling: Fire-retardant-treated wood shall be labeled as required by the code and shall bear the UL Classification Mark.

2.02 PRODUCT SUBSTITUTIONS

- A. Requests for substitutions will be considered in accordance with provisions of Section 01 25 00 - Substitution Procedures.

2.03 RELATED MATERIALS

- A. Wood Materials: Refer to Division 6 Sections for related wood materials required to be treated as specified herein.

PART 3 EXECUTION

3.01 MANUFACTURER'S INSTRUCTIONS

- A. Comply with manufacturer's product data, including product literature, technical bulletins, and installation instructions.

3.02 EXAMINATION

- A. Discard pieces with defects which might impair quality or work.
- B. Examine for wet conditions before installation. Do not install fire-retardant-treated wood that is wet or has been wet until it is dried to the original specified moisture content.

3.03 INSTALLATION

- A. Install fire-retardant-treated wood in accordance with code requirements and related Division 6 Sections.
- B. Install interior fire-retardant-treated wood where exterior type is not indicated.
- C. Install exterior fire-retardant-treated wood for weather-exposed surfaces and where indicated.
- D. Field cutting of fire-retardant-treated wood to length is allowed without end-treating. Do not rip or mill lumber after fire-retardant treatment; end cuts and drilling of holes are permitted. Fire-retardant-treated plywood may be cut in any direction.
- E. Install fire-retardant-treated wood using manufacturer's recommended fasteners.

3.04 CONSTRUCTION

- A. Allow fire-retardant-treated wood that has become wet during construction to dry to original specified moisture content before being enclosed.

3.05 FINISHING

- A. Prepare fire-retardant-treated wood surfaces to be finished in accordance with manufacturer's finishing recommendations.
- B. Apply paint or stain in accordance with Section 09 90 00 - Painting and Coating.

FIRE-RETARDANT-TREATED WOOD
LISTED, LABELED, & PRESSURE-IMPREGNATED

HOOVER
TREATED WOOD PRODUCTS, INC.
800-TEC-WOOD / TECWOOD@FRTW.COM

Learn About Fire-Retardant-Treated Wood

From the Industry Leader

Call today to schedule your free seminar!



PYRO-GUARD
— HOOVER —
TREATED WOOD PRODUCTS, INC.
THOMSON, GA MILFORD, VA
WINSTON, OR PINE BLUFF, AR
DETROIT, MI BAKERSFIELD, CA
OXFORD, PA
PROCESS CONTROL
STANDARD 2200P
MONITORED BY:
TIMBER PRODUCTS INSPECTION
AA-696 UL ER7002-01
MEA-359-88-M LA-RR25150
18 KDAT 19

CLASSIFIED
UL
TREATED LUMBER
15P9 R7002
SOUTHERN YELLOW PINE
SURFACE BURNING CHARACTERISTICS:
FLAME SPREAD: 10
SMOKE DEVELOPED: 35
30 MINUTE TEST

**2-Hour FRTW
Bearing Wall
Assembly**

**UL Design
No. V314**



**AIA CES
Approved
Provider**



**Evaluation
Report
UL ER7002-01**



**Preferred
Education
Provider**



Take our free online class: LearnAboutFRTW.com